Conext™ ComBox Multi-Cluster Setup Documentation Update

976-0314-01-01
Rev A

THIS DOCUMENTATION UPDATE IS IN ADDITION TO, AND INCORPORATES BY REFERENCE, THE RELEVANT PRODUCT MANUALS FOR EACH PRODUCT IN THE CONEXT COMBOX. BEFORE REVIEWING THIS DOCUMENTATION UPDATE YOU MUST READ THE RELEVANT PRODUCT MANUALS. UNLESS SPECIFIED, INFORMATION ON SAFETY, SPECIFICATIONS, INSTALLATION, AND OPERATION IS AS SHOWN IN THE PRIMARY DOCUMENTATION RECEIVED WITH THE PRODUCT. ENSURE YOU ARE FAMILIAR WITH THAT INFORMATION BEFORE PROCEEDING.

Purpose

The purpose of this Documentation Update is to explain the multi-cluster setup of two or more Conext ComBox units. It supplements the Conext ComBox Owner's Guide (Doc Number: 975-0679-01-01).

Audience

This Documentation Update is intended for use by anyone who plans to construct, install, or operate a system involving the Conext ComBox. The information in this manual is intended for qualified personnel. Qualified personnel have training, knowledge, and experience in:

- Installing electrical equipment
- Applying all applicable installation codes
- Analyzing and reducing the hazards involved in performing electrical work
- Changing any TCP/IP-related settings

Table of Contents

- ComBox Setup in a Large Multi-Cluster System
- Setting Up a Unified Network with Multiple ComBox Units
- Connecting the Conext ComBox Master Device to a Computer on an Ethernet Network
- Configuring ComBox Master and Slave Devices
- Accessing ComBox Slave Devices Directly

ComBox Setup in a Large Multi-Cluster System

Conext ComBox Master-Slave Configuration

The ComBox can be set up in a master-slave configuration to monitor multiple separate Xanbus networks and supported Modbus devices, such as power meters. This configuration can be used for large multi-cluster systems as well as smaller systems when devices need to exist on separate ComBoxes.

Using a Master-Slave Configuration, multiple Xanbus networks on separate ComBoxes can be combined and monitored through the Master ComBox. When multiple ComBoxes have been added to the system, the settings of the slaves can be controlled and modified by the Master ComBox. Data is reported by the Slave ComBox to the Master ComBox. The Master ComBox is for data aggregation only and has no Xanbus or Modbus devices attached directly. RS-485 devices and principal devices such as XW+, AGS, SCP, etc. are placed on one of the slave ComBoxes. See the simplified illustration below.

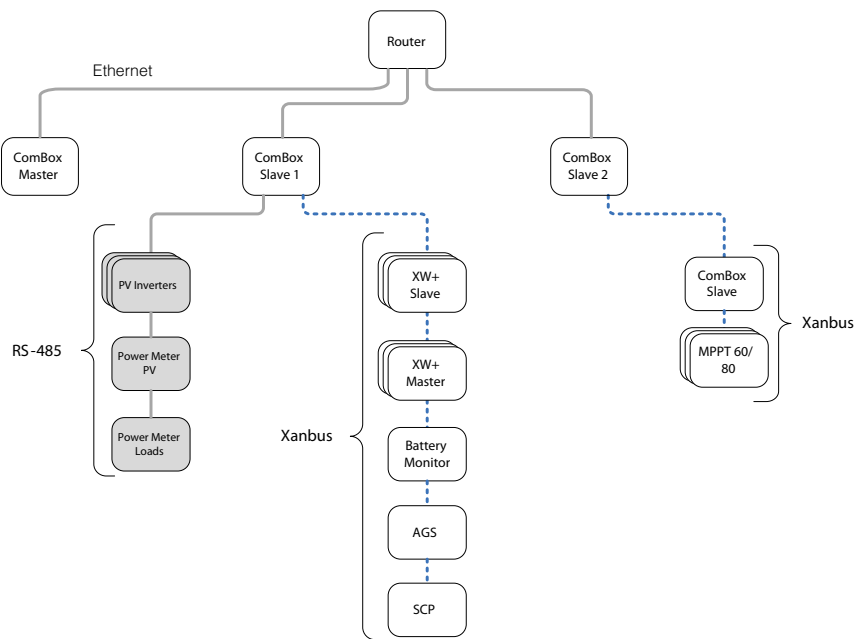

Note: Compatibility between different firmware versions in a Master/Slave system is not guaranteed. Therefore, ensure the same firmware version is installed on all ComBoxes in a Master/Slave system.

Conext ComBox Setup in a large Multi-Cluster System

A power system is a network of power devices such as inverters, PV arrays, generators, charge controllers, battery banks, and monitoring devices. Power systems can be grid-tied backup systems or off-grid solar.

Within a large power system where you have the possibility of exceeding Xanbus network sizing requirements (see Xanbus Network Sizing Guide for Conext XW+ Systems, Doc Number: 975-0646-01-01), it may be necessary to form groups

together with power devices using multiple ComBox devices. A ComBox Master device is assigned to serve as the main monitoring device while one or more ComBox Slave devices are used to group functional devices together.

In Figure 1, power devices are grouped together in two separate Xanbus networks. The first Xanbus network is composed of eight MPPT 80 600 charge controllers and one SCP. The second Xanbus network is composed of twelve Conext XW+ inverters, four battery monitors, one AGS, and one SCP. Each Xanbus network is monitored by its own ComBox slave device. The two Xanbus networks are joined together by a single Combox master device.

Note: When there are more than 6 Conext XW's or 10 Conext MPPT devices, it is not recommended to use the ComBox (or SCP with cascading settings) to configure settings on the attached Xanbus devices. Adjusting device settings from the ComBox on such a large system can be unreliable. Use the *Conext Configuration Tool* (p/n 865-1155-01) with supplied software to configure device settings on such large systems.

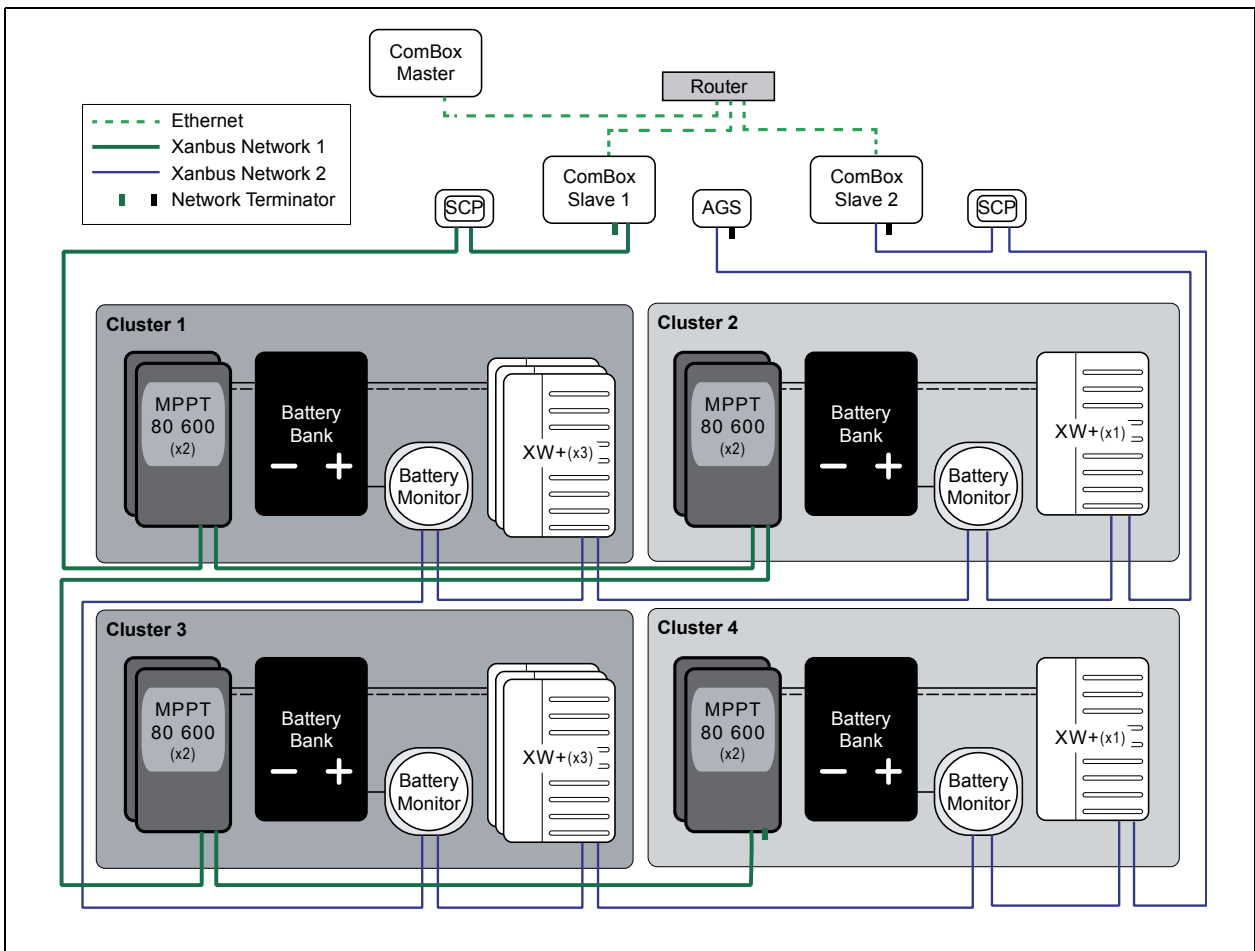

Figure 1 ComBox in a Multi-Cluster System



Unified Network

In Figure 1, the two Xanbus networks are combined to form one unified network monitored by a ComBox Master device. It is possible that you can also have RS-485 devices such as power meters, weather sensors, pyranometers on a single network or combined with a Xanbus network on a ComBox device. You may also already have an existing network of Xanbus and RS-485 devices and just looking to expand.

Clusters

Clusters within the context of a ComBox monitored network can be formed when two or more ComBox devices are joined together. When a unified network has been established one Conext ComBox device acts as a Master device and another or more ComBox devices are designated as Slave devices.

Clusters are formed by associating power devices to a battery bank. A power device has its Device Settings in the ComBox web interface.

Each Device Settings has either Associations  Associations or Multi-Unit Configuration  Multi-unit Configuration

Within either Associations or Multi-unit Configuration is a parameter called DC Association (Battery) 

Setting Up a Unified Network with Multiple ComBox Units

Figure 1, “ComBox in a Multi-Cluster System” on page 3 is the basis of the following set of instructions.

NOTE: Depending on how different your setup is from the example in Figure 1, determine which of the instructions below are appropriate. Some instructions are loaded instructions that require qualified personnel to properly interpret (see DANGER box below). Instructions that are not applicable to Figure 1 are labeled with TIP.

DANGER

ELECTRICAL SHOCK AND FIRE HAZARD

- All wiring should be done by qualified personnel to ensure compliance with all applicable installation codes and regulations.
- Apply appropriate personnel protective equipment (PPE) and follow safe electrical work practices. See NFPA 70E, CSA Z462, or PPE Directive 89/686/EEC.
- Never operate energized inverters, chargers, charge controllers, and all other power devices with covers removed.
- Inverter/chargers and other power devices are energized from multiple sources. Before removing covers identify all sources, de-energize, lock-out, and tag-out and wait two minutes for circuits to discharge.
- Always use a properly rated voltage sensing device to confirm all circuits are de-energized.

Failure to follow these instructions will result in death or serious injury.

Materials Needed (Based on Figure 1 “ComBox in a Multi-Cluster System”):

- 3 Conext ComBox devices
- 1 DHCP network router with multi-port switch
- 3 Ethernet cables
- 1 Laptop computer with a LAN/Ethernet port and USB 1.1/ 2.0 compatible port
- 8 Conext XW+ inverter/chargers
- 4 Conext Battery Monitors
- 8 Conext MPPT 80 600 Charge Controllers
- 2 SCP
- 1 AGS
- 4 network terminators (included with all xanbus devices except for AGS)
- Multiple Xanbus network cables (one included with each Xanbus-enabled device, however may require extra)
- Batteries, DC breaker switches, DC cables
- PC or laptop using *Conext Configuration Tool* (p/n 865-1155-01) with supplied software

Set up the first ComBox Slave Network (see Xanbus Network 1 in Figure 1 on page 3)

NOTE: Refer to the section “Types of Conext ComBox Networks” in the Conext ComBox Installation and Configuration Manual (Doc Number: 975-0679-01-01).

1. Install all power devices including one ComBox, four battery monitors, three charge controllers, and one SCP.

To install Xanbus-enabled devices, please follow the instructions laid out in the corresponding Installation Guide for each device.

TIP To install RS-485 devices, please follow the manufacturer’s installation instructions specific to each RS-485 device.

2. Designate the ComBox as **ComBox Slave 1** device.
3. Daisy-chain the ComBox, battery monitors, charge controllers, and SCP with Xanbus network cables. Terminate the two ends of the daisy-chain network with network terminators.

TIP To connect RS-485 devices to a ComBox network, follow the instructions in the Conext ComBox Installation and Configuration Manual.

Set up the second ComBox Slave Network (see Xanbus Network 2 in Figure 1 on page 3)

4. Install all power devices including one ComBox, eight Conext XW+ inverter/chargers, one SCP, and one AGS.

To install Xanbus-enabled devices, please follow the instructions laid out in the corresponding Installation Guide for each device.

TIP To install RS-485 devices, please follow the manufacturer’s installation instructions specific to each RS-485 device.

5. Designate (label) the ComBox as **ComBox Slave 2** device.
6. Daisy-chain the ComBox, XW+, and AGS with Xanbus network cables. Terminate the two ends of the daisy-chain network with network terminators.

TIP To connect RS-485 devices to a ComBox network, follow the instructions in the Conext ComBox Installation and Configuration Manual.

Install the House Battery Banks

7. Install four House Battery Banks.
8. Connect each battery bank to a battery monitor.

Install the ComBox Master Device

9. Install one ComBox.
10. Designate (label) the ComBox as the **ComBox Master** device.
11. Install one network router.

Install the ComBox Slave Devices

12. Connect an Ethernet cable between **ComBox Slave 1** and the network router. Make sure that the Ethernet cable is connected to a vacant Ethernet/LAN port on the network router.
13. Connect an Ethernet cable between **ComBox Slave 2** and the network router. Make sure that the Ethernet cable is connected to a vacant Ethernet/LAN port on the network router.

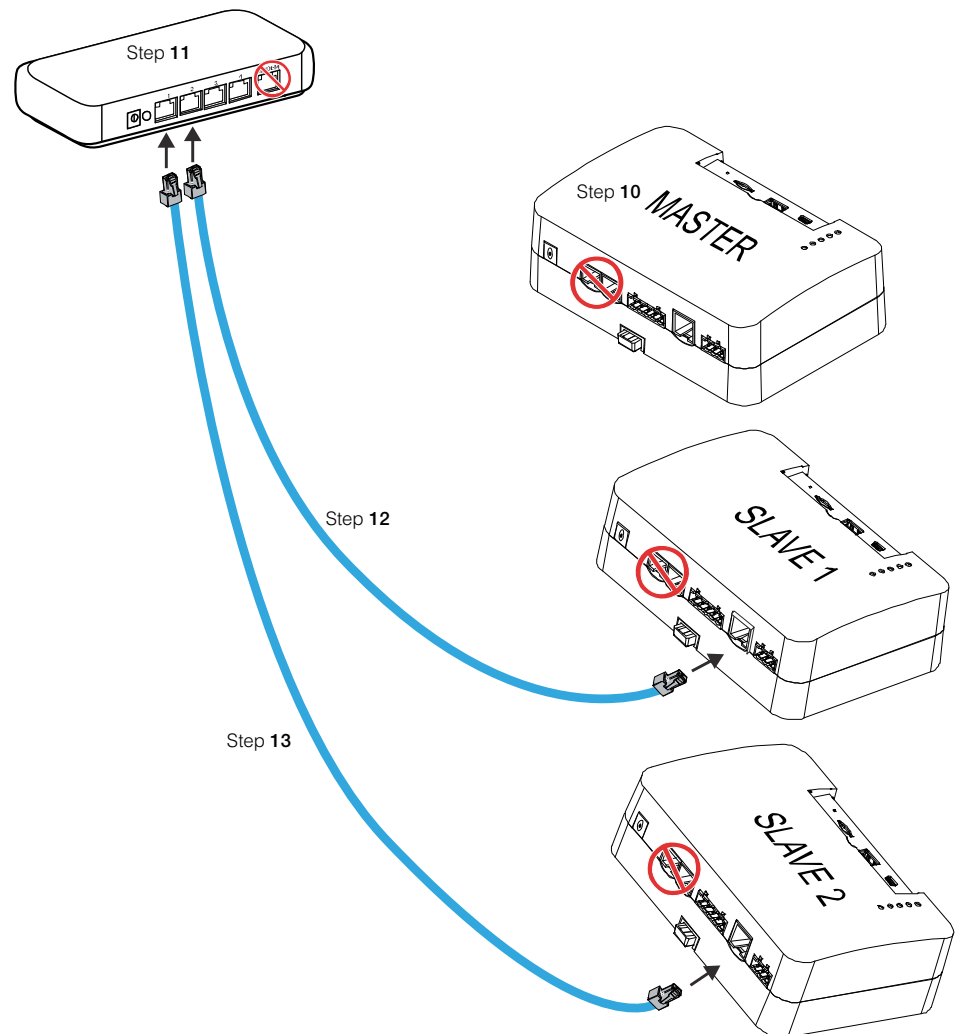

Connecting the Conext ComBox Master Device to a Computer on an Ethernet Network

NOTE: The computer and network router may remain powered at this stage in the process. If not already powered, make sure these two devices are powered on before proceeding.

Before connecting a computer and router to the ComBox, make sure it meets the following prerequisites.

Router

The network router must be able to supply DHCP addresses automatically to connected devices. If your network router does not support automatic DHCP, refer to your network router's user guide or contact your system administrator.

Operating System

- Microsoft® Windows® 7 (recommended) or later
- Windows Vista® X86
- Mac OS® X 10.4.8. or later

Web Browsers

- Mozilla® Firefox® 12.x or later
- Microsoft® Windows® Internet Explorer® 10.x or later
- Google Chrome™ 34.x or later
- Safari® 5.x or later

NOTE: JavaScript and cookies must be enabled in your web browser.

To connect the ComBox to a Computer on an Ethernet Network:

1. Make sure the computer and network router are powered on and the ComBox is off. Make sure the network router selected has DHCP enabled.
2. Connect one end of an Ethernet cable to the computer's network port.

NOTICE

EQUIPMENT DAMAGE

- Do not connect an Ethernet cable from the ComBox to the WAN/MODEM port on the network router.
- Do not connect an Ethernet cable plug into a Xanbus port on the ComBox.

Failure to follow these instructions can damage equipment.

3. Connect the other end of the Ethernet cable to a vacant Ethernet/LAN port on the network router.

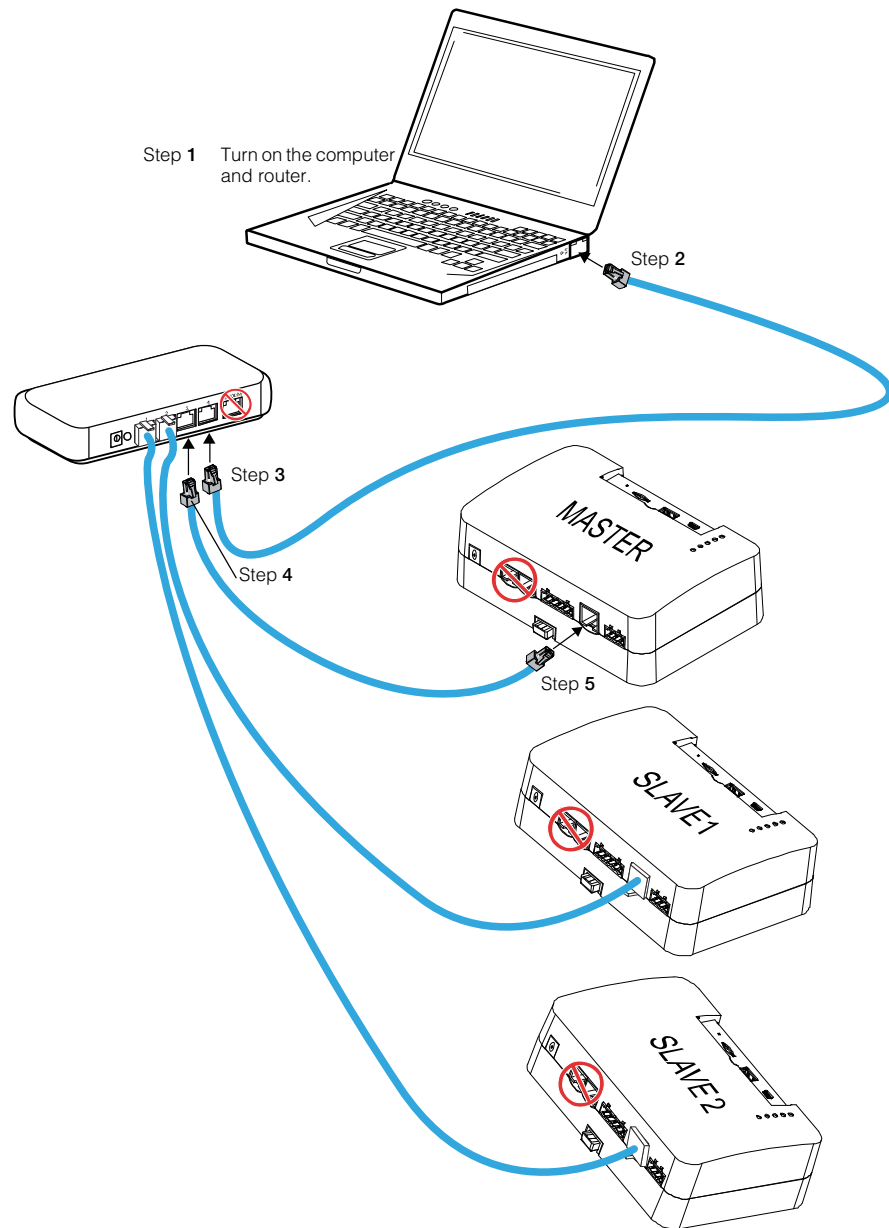

4. Connect one end of the Ethernet cable (supplied) to the LAN port on the network router.
At this stage, the network router should be on but the LED showing port activity on the router will not show any indication.
5. Connect the other end of the Ethernet cable to the ComBox.
At this stage the Ethernet cable should be the only cable (except for the Dry Contact if used) plugged into the ComBox.

6. Turn on the ComBox Master Device using its AC/DC Power Adapter. See the ComBox Installation and Configuration Guide section “Turning On the Conext ComBox”.
7. Find the Conext ComBox Master Device on the Network. See the ComBox Installation and Configuration Guide section “Finding the Conext ComBox on the Network”.
8. Log in to the Conext ComBox Master Device’s Web User Interface.
 - If logging in using a thumb drive, see the ComBox Installation and Configuration Guide section “Logging in to the Conext ComBox Web User Interface Using a USB Thumb Drive”.
 - If the device’s URL is known, see ComBox Installation and Configuration Guide section “Logging In”.

On the left hand side of the web interface, when you expand ComBox Configuration expect to find something similar below.

NOTE: When using the web interface of the master ComBox, there should be no web browser (or tablet) device connected to the slave ComBox’s webservice.

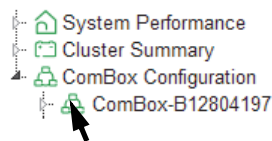

Take note of the device name of this ComBox you have labeled as Master.

9. Click on the ComBox device. The Conext ComBox Status Information appears.

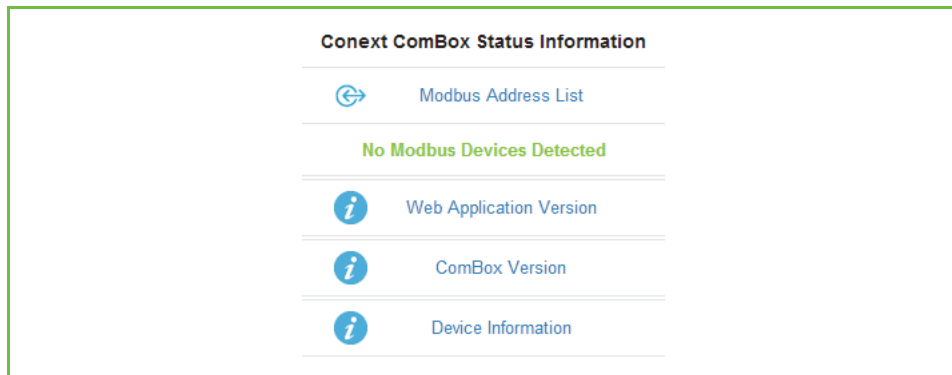

10. Turn on the ComBox Slave devices using their own AC/DC Power Adapters.

Configuring ComBox Master and Slave Devices

NOTE: This section describes only how to configure Master and Slave devices. For information on setting the time, changing passwords, and other ComBox settings, refer to the ComBox Installation and Configuration Guide.

Also, you may choose to connect the ComBox devices to the Xanbus network before proceeding further. Please follow the steps including the notes and notices in the section “Connecting the Conext ComBox to the Xanbus Network” in the ComBox Installation and Configuration Guide.

1. Expand the ComBox (labeled as Master) to bring up its Configuration setting.

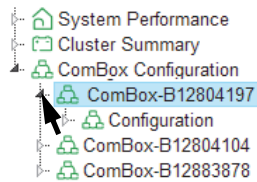

In this example, ComBox-B12804197 is the ComBox that was labeled as Master in step 8 of the previous section.

2. Click Configuration to bring up the Conext ComBox Quick Settings.

Conext ComBox Quick Settings	
Parameter	Value
Device Friendly Name	<input type="text" value="ComBox-B12814197"/> ↻ 💾
Reboot Conext ComBox	Reboot
Shutdown Conext ComBox	Shutdown
Reset All Downstream Devices	Reboot Reset to Factory
Clear All Downstream Devices	Active Faults Active Warnings
Set Operating Mode For All Downstream Devices	Standby Operating

3. Change the Device Friendly Name, if desired. Then save the setting.
4. Repeat steps 1 to 3 for the other ComBox devices.

Changing the Mode of each ComBox

5. Expand the Configuration setting to bring up Settings.
6. Click Settings for the ComBox labeled as Master.

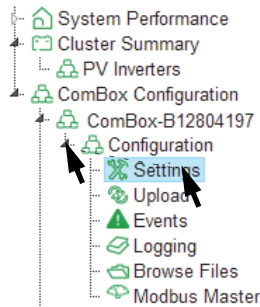

The Conext ComBox Settings page appears on the right panel.

7. Search for the Multi Cluster setting. Scroll down, if necessary.
8. Click Multi Cluster to bring up its settings.

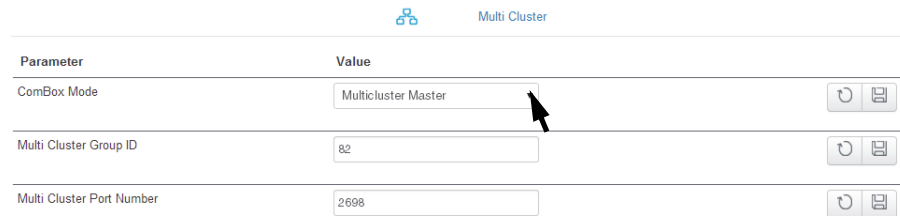

9. Change the ComBox Mode parameter to a value of Multicluster Master.
10. Click Settings for the next ComBox device.

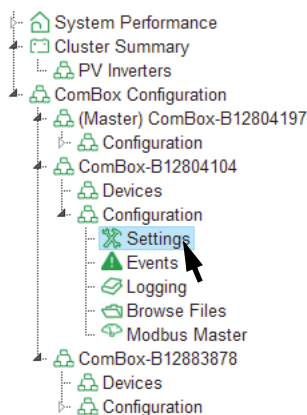





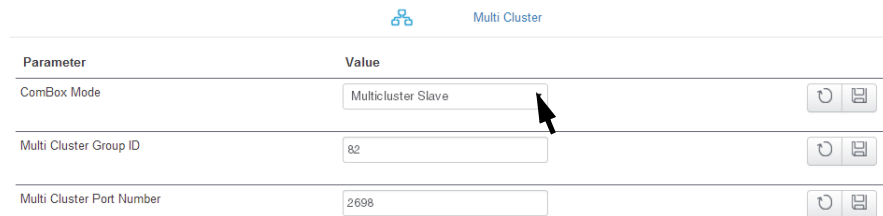

The Conext ComBox Settings page appears on the right panel.

11. Search for the Multi Cluster setting. Scroll down, if necessary.

12. Click Multi Cluster to bring up its settings.



Multi Cluster

Parameter	Value	
ComBox Mode	Multicluster Slave	 
Multi Cluster Group ID	82	 
Multi Cluster Port Number	2698	 

NOTE: Multi-Cluster port number and group ID must be the same for each ComBox in a Master/Slave configuration, or they will not be able to communicate with each other.

13. Change the ComBox Mode parameter to a value of Multicluster Slave.

14. Repeat steps 10 to 13 for succeeding ComBox Slave devices.

Multi-Cluster Master/Slave ComBox Usage Restrictions

The following points detail certain restrictions and important facts that must be observed when configuring the ComBox for Master/Slave use:

- The master ComBox has no awareness of the devices attached to the slave ComBoxes. Even though device settings can be set through the master, this is actually performed through a tunnel to the web interface of the slave ComBox.
- The Master only aggregates summary data (e.g. energy totals) from each slave ComBox.
- The master cannot log slave device settings, so any non-summary (device-specific) data logging must be done on the slave ComBoxes.
- When using a Master / Slave system with the cloud (Conext Insight), the Master ComBox pushes the aggregated data, and the slaves push only device configurations, device faults, and device warnings. Cloud connectivity must be enabled on all ComBoxes on the site to enable full system visibility.
- When using a Modbus Master tool or device to communicate with the Master/Slave ComBox system, a Modbus connection is required to each ComBox to control and read status from the devices attached to that ComBox. Modbus commands are not cascaded between ComBoxes.
- Settings made on one ComBox do not automatically cascade to the other ComBoxes on a site.
- It is not recommended to use the ComBox to set device settings (particularly when cascading is enabled) on systems with more than 6 Conext XWs or 10 MPPTs. Use of a PC with the *Conext Configuration Tool* and software is recommended in these cases.
- The tablet app is not compatible with the master/slave ComBox configuration. The tablet app can only connect to one ComBox at a time, and will only allow connections to ComBoxes configured for a stand-alone mode of operation.
- When performing a firmware upgrade of Xanbus devices in a Master/Slave system (or in any system with a large number of Xanbus devices), it is recommended to power on only the Xanbus device being upgraded and leave all other Xanbus devices powered off to improve the speed and reliability of the upgrade.
- When using a Master/Slave ComBox system with the Conext Insight portal, it is recommended to enable Data Push Synchronization and select the same Data Push Synchronization String for each ComBox on the site to ensure that each ComBox pushes its data to the portal at the same time.

Setting up Clusters

NOTE: The ComBox devices must be connected to the Xanbus network at this time and the Xanbus devices must be connected, energized, and placed in Standby mode.

1. Click the Device Setting of a power device in one of the ComBox Slave devices. The Device Settings page appears on the right panel.

The screenshot shows the 'XW (1) - Device Settings' page. The left sidebar contains a tree view of the system configuration, with 'XW (1)' selected under 'Devices'. The main panel shows the 'XW (1) - Device Settings' page with various configuration options. The 'Associations' section is highlighted, showing a table of parameters and their values.

Parameter	Value
AC1 Association (Grid)	Grid 1
AC2 Association (Generator)	Generator 1
AC Output Association (Loads)	AC Load 1
DC Association (Battery)	House Battery Bank 1

2. Click the Associations setting for the device.
3. Change the DC Association (Battery) parameter to House Battery Bank 1 if you want the device to belong to Cluster 1.
Change the parameter to House Battery Bank 2 if you want the device to belong to Cluster 2, and so on.
4. Repeat steps 1 to 3 with every power device in all ComBox Slave devices.

NOTES: For some Xanbus devices such as MPPT Charge Controllers and Battery Monitors, the DC Association (Battery) setting is found under Multi-unit Configuration.

The AGS parameter for battery association is called DC Input Association.

Xanbus devices such as the SCP cannot be associated to a cluster.

Accessing Power Devices from the ComBox Master

5. Use the instructions and notices in the section “Changing Device Settings” in the ComBox Installation and Configuration Guide to view and modify each of the power devices in the system.

Accessing ComBox Slave Devices Directly

NOTE: The ComBox Master device is the recommended device to access multi-cluster settings. However, ComBox Slave devices can also be accessed separately if you obtain the IP addresses of each slave device.

Accessing a ComBox Slave device from the Master device

1. Select a slave device from the left panel of the web interface.

NOTE: Do not access a slave ComBox directly unless you first log out of the master ComBox.

Finding out the IP address of a slave device

2. Access the Configuration Settings of a slave device.

The screenshot shows the web interface for accessing a slave device. On the left is a navigation tree with 'Settings' selected under 'ComBox-B12804104'. On the right, the 'Conext ComBox Settings' page is displayed, with 'TCP/IP Settings' selected. A table below lists network parameters:

Parameter	Value	
TCP/IP Address	10.167.71.85	[Refresh] [Save]
TCP/IP Net Mask	255.255.255.0	[Refresh] [Save]
Gateway Address	10.167.71.1	[Refresh] [Save]
DNS Server Address	10.167.77.80	[Refresh] [Save]

3. Click the TCP/IP Settings for the device.
4. Write down the TCP/IP Address.

Logging into the ComBox slave device

5. Open a new internet browser window.
6. Enter the TCP/IP Address on the URL field and press Enter.
7. Log in as usual.

Alternatively, you can extract the slave device’s IP address using a thumb drive inserted into its USB port. Follow the instructions in the ComBox Installation and Configuration Guide section “Logging in to the Conext ComBox Web User Interface Using a USB Thumb Drive” to log in.

Copyright © 2014 Schneider Electric. All Rights Reserved.

All trademarks are owned by Schneider Electric Industries SAS or its affiliated companies.

Exclusion for Documentation

UNLESS SPECIFICALLY AGREED TO IN WRITING, SELLER

(A) MAKES NO WARRANTY AS TO THE ACCURACY, SUFFICIENCY OR SUITABILITY OF ANY TECHNICAL OR OTHER INFORMATION PROVIDED IN ITS MANUALS OR OTHER DOCUMENTATION; (B) ASSUMES NO RESPONSIBILITY OR LIABILITY FOR LOSSES, DAMAGES, COSTS OR EXPENSES, WHETHER SPECIAL, DIRECT, INDIRECT, CONSEQUENTIAL OR INCIDENTAL, WHICH MIGHT ARISE OUT OF THE USE OF SUCH INFORMATION. THE USE OF ANY SUCH INFORMATION WILL BE ENTIRELY AT THE USER'S RISK; AND (C) REMINDS YOU THAT IF THIS DOCUMENTATION IS IN ANY LANGUAGE OTHER THAN ENGLISH, ALTHOUGH STEPS HAVE BEEN TAKEN TO MAINTAIN THE ACCURACY OF THE TRANSLATION, THE ACCURACY CANNOT BE GUARANTEED. APPROVED CONTENT IS CONTAINED WITH THE ENGLISH LANGUAGE VERSION WHICH IS POSTED AT www.schneider-electric.com.

Date: July 2014

Revision: Rev A

Document Number: 976-0314-01-01

Contact Information

www.SEsolar.com

For other country details please contact your local Schneider Electric Sales Representative or visit the Schneider Electric website at <http://www.SEsolar.com>.